

# THE BERKLEY

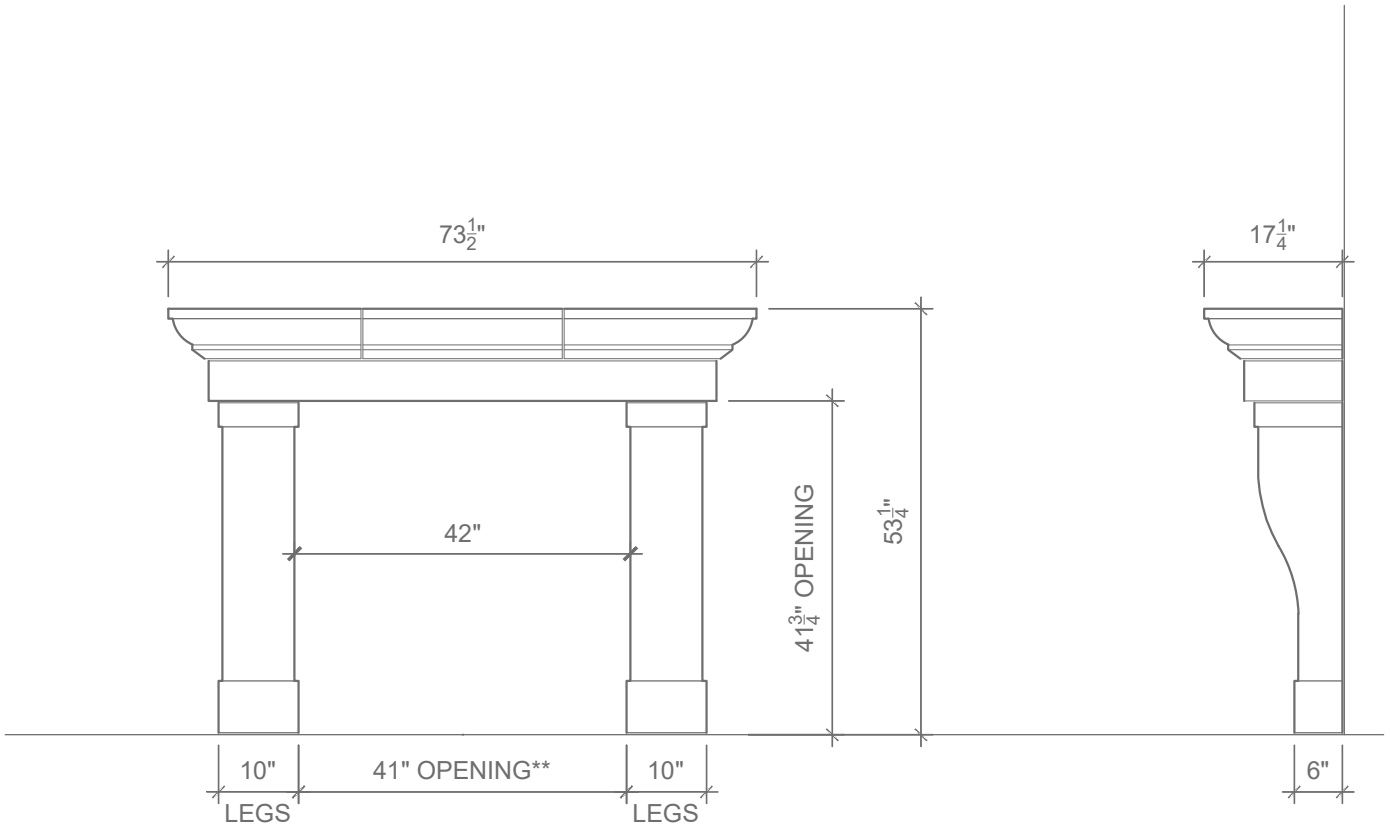

**1** FRONT (SHOWN IN 42" MODEL)  
SCALE: 1/2"=1'-0"

**2** SIDE  
SCALE: 1/2"=1'-0"

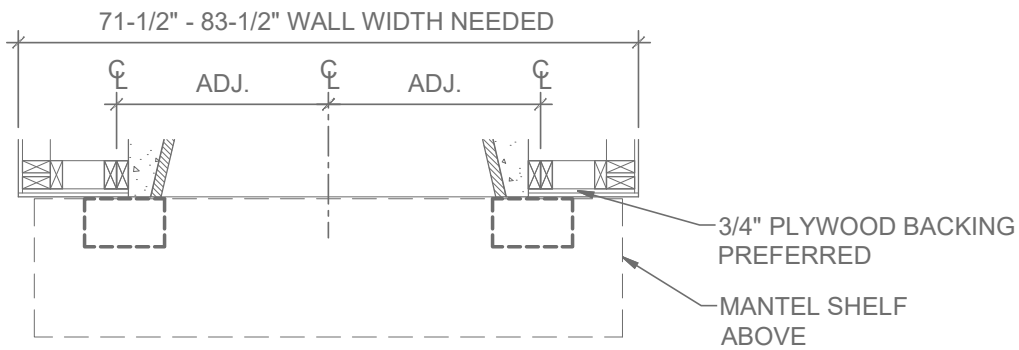

**3** FRAMING PLAN  
SCALE: 1/2"=1'-0"

\*ALL JOINTS ARE AT  $1/4"$  UNLESS NOTED OTHERWISE  
\*\*THIS MANTEL IS AVAILABLE IN 36", 42", AND 48" NOMINAL SIZES

# HEARTH OPTIONS

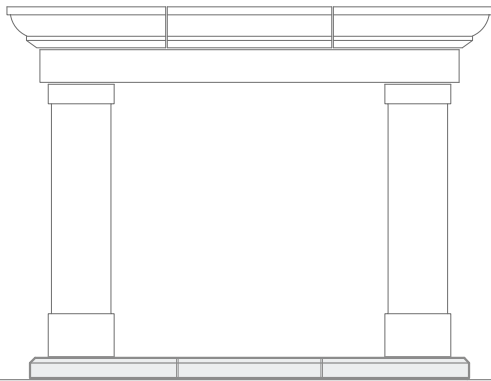

CHAMFERED EDGE  
SQUARE HEARTH

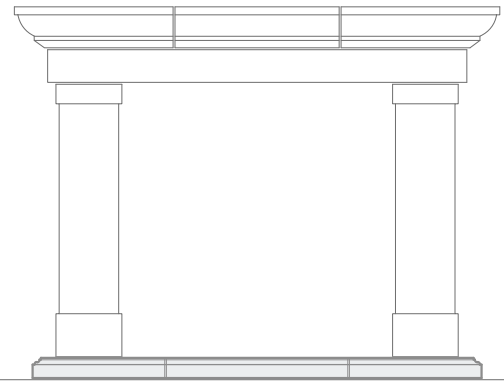

OGEE EDGE  
SQUARE HEARTH

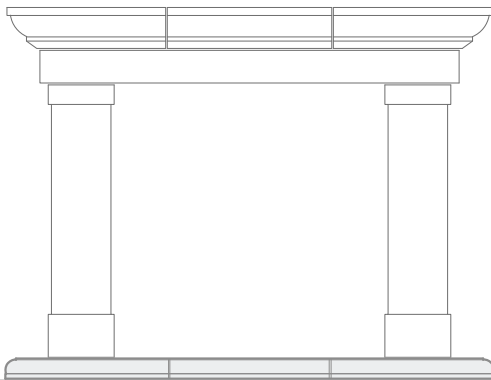

RADIUS EDGE  
EYEBROW HEARTH\*



\*SIZES LIMITED FOR EYEBROW HEARTH

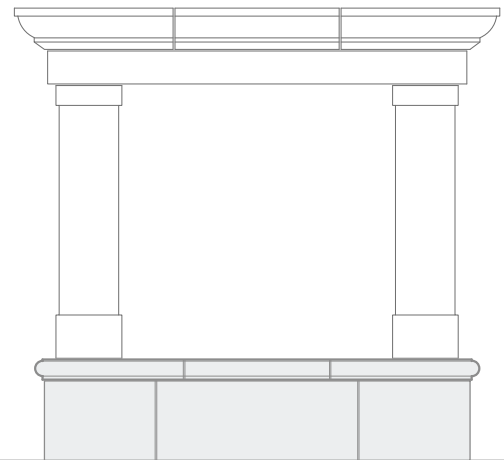

BULLNOSE EDGE, SQUARE  
HEARTH WITH RAISED PANELS



VISIT OPTIONS PAGE FOR MORE INFORMATION

# FILLER PANEL OPTIONS

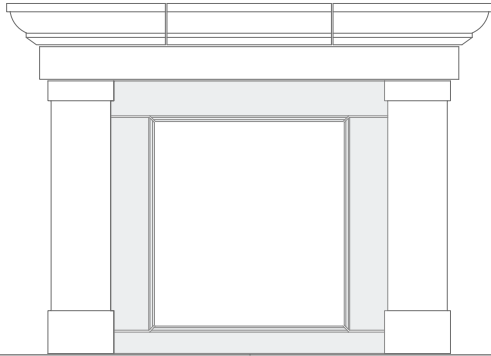

OGEE EDGE, STRAIGHT  
FILLER PANEL



CHAMFER EDGE, STRAIGHT  
FILLER PANEL \*

\*SHOWN WITHOUT BOTTOM PANEL

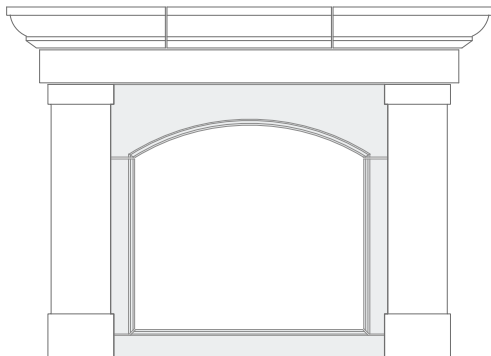

OGEE EDGE, EYEBROW  
FILLER PANEL \*\*

\*\*SIZES LIMITED FOR EYEBROW FILLER PANELS

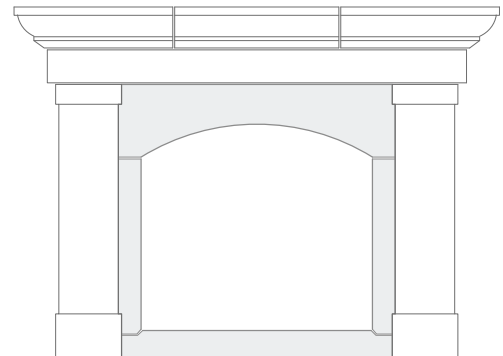

SQUARE EDGE, EYEBROW  
FILLER PANEL \*\*

VISIT OPTIONS PAGE FOR MORE INFORMATION