

# THE BORDEAUX

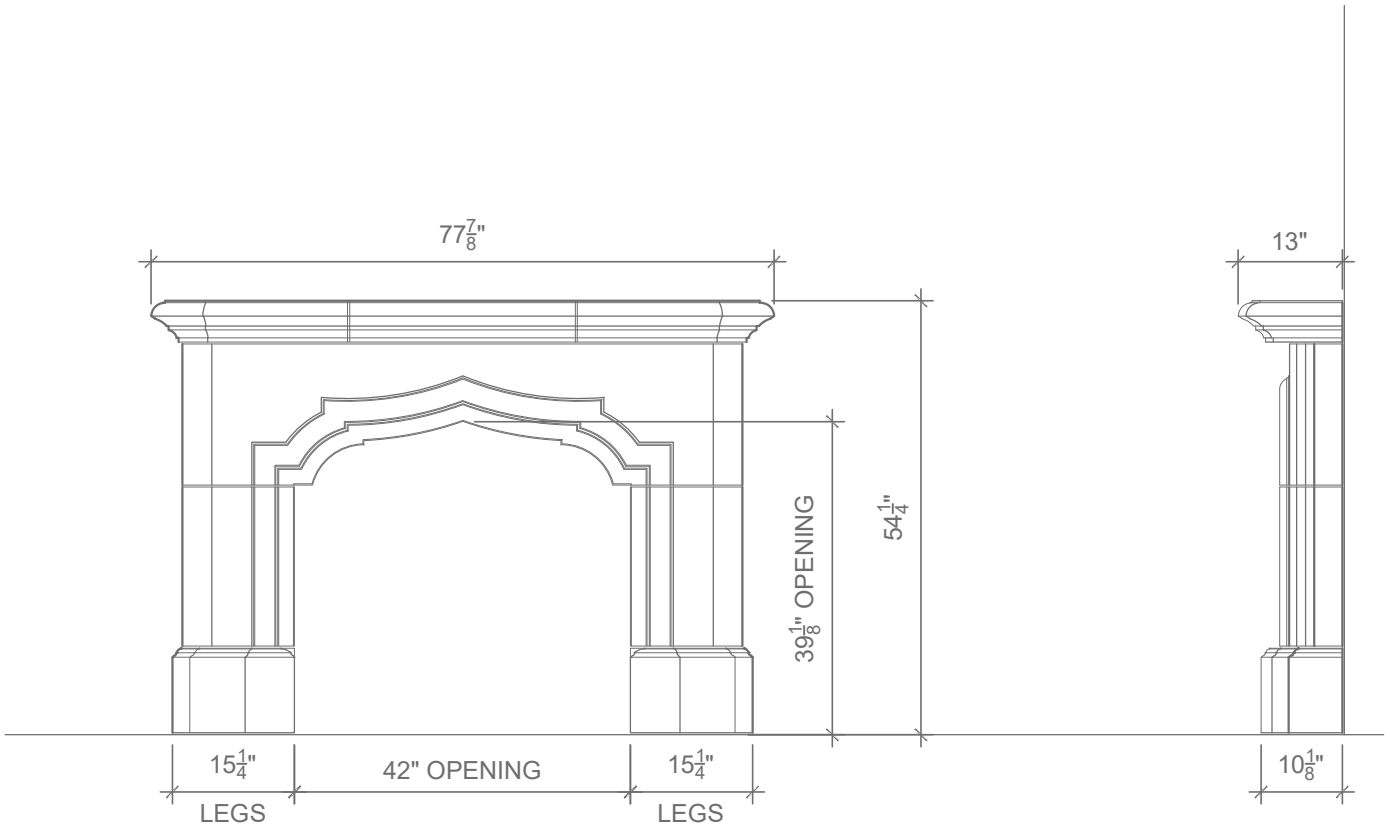

**1 FRONT**  
SCALE: 1/2"=1'-0"

**2 SIDE**  
SCALE: 1/2"=1'-0"

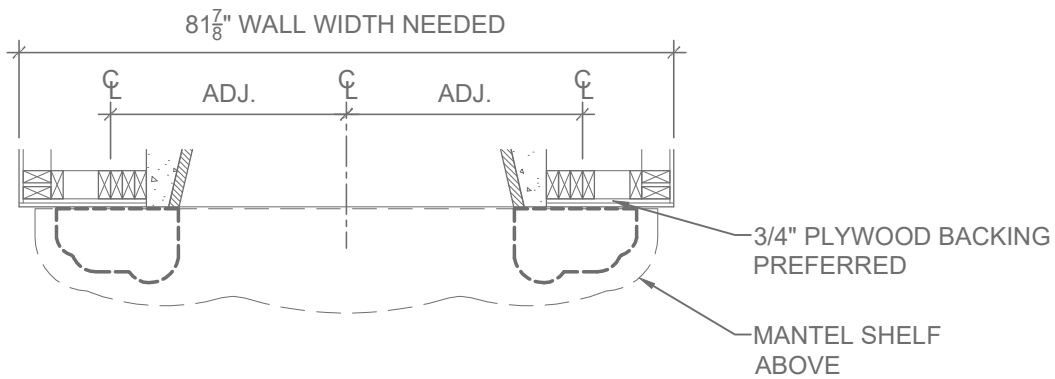

**3 FRAMING PLAN**  
SCALE: 1/2"=1'-0"

\*ALL JOINTS ARE AT 1/4" UNLESS NOTED OTHERWISE

# HEARTH OPTIONS

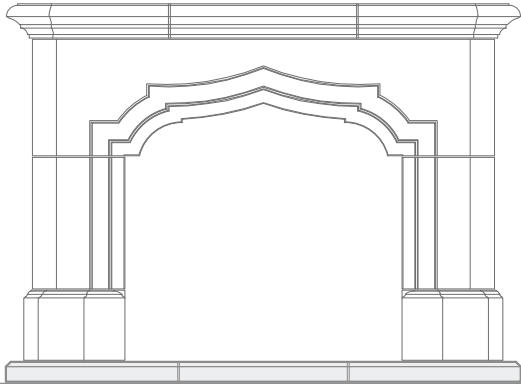

CHAMFERED EDGE  
SQUARE HEARTH

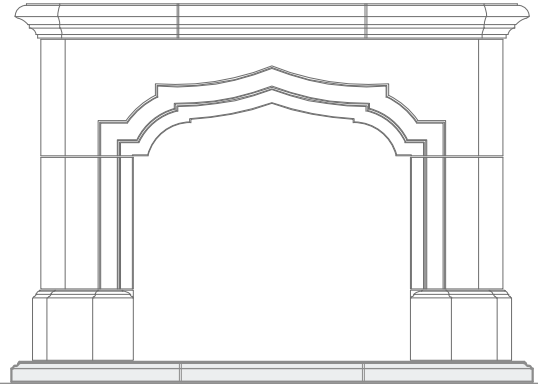

OGEE EDGE  
SQUARE HEARTH

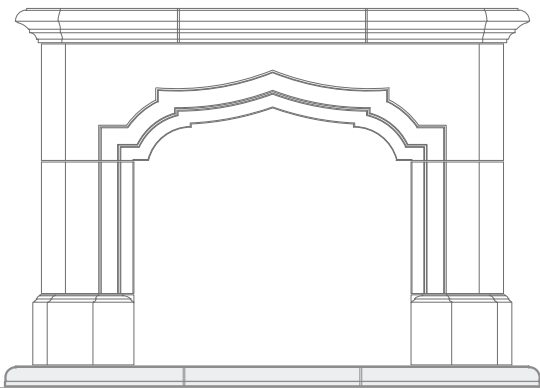

RADIUS EDGE  
EYEBROW HEARTH\*



\*SIZES LIMITED FOR EYEBROW HEARTH

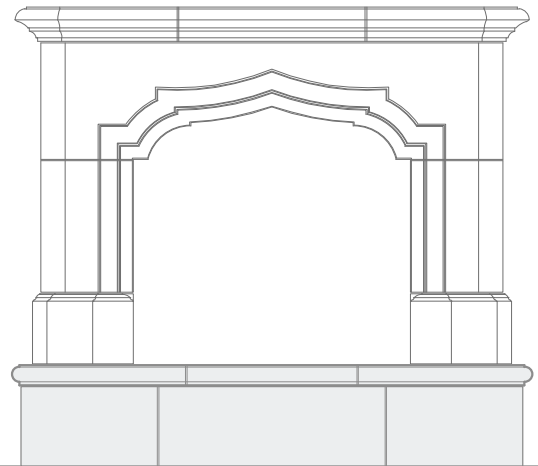

BULLNOSE EDGE, SQUARE  
HEARTH WITH RAISED PANELS



VISIT OPTIONS PAGE FOR MORE INFORMATION

# FILLER PANEL OPTIONS

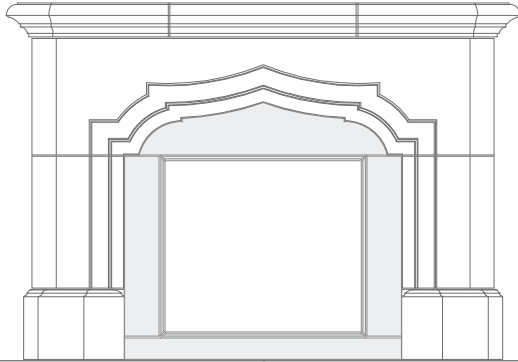

OGEE EDGE, STRAIGHT  
FILLER PANEL

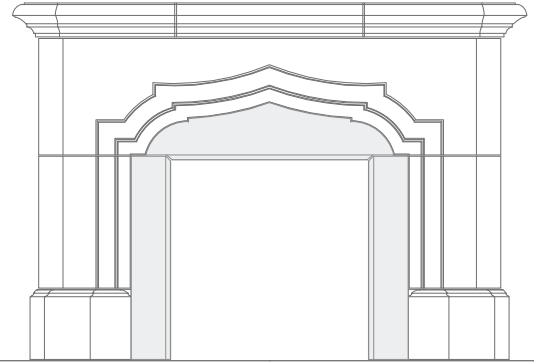

CHAMFER EDGE, STRAIGHT  
FILLER PANEL\*

\*SHOWN WITHOUT BOTTOM PANEL

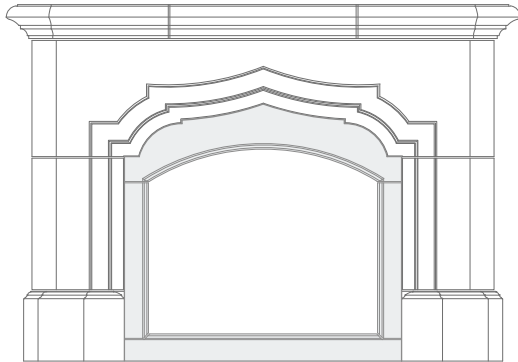

OGEE EDGE, EYEBROW  
FILLER PANEL\*\*

\*\*SIZES LIMITED FOR EYEBROW FILLER PANELS

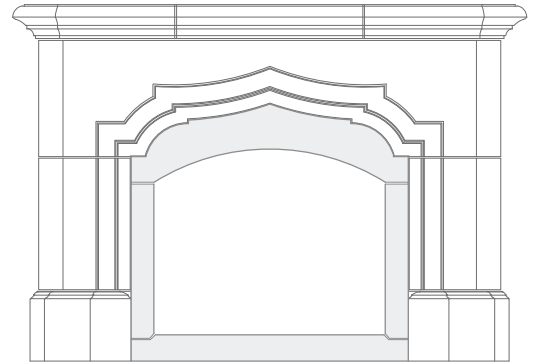

SQUARE EDGE, EYEBROW  
FILLER PANEL\*\*

VISIT OPTIONS PAGE FOR MORE INFORMATION