

THE NEWPORT

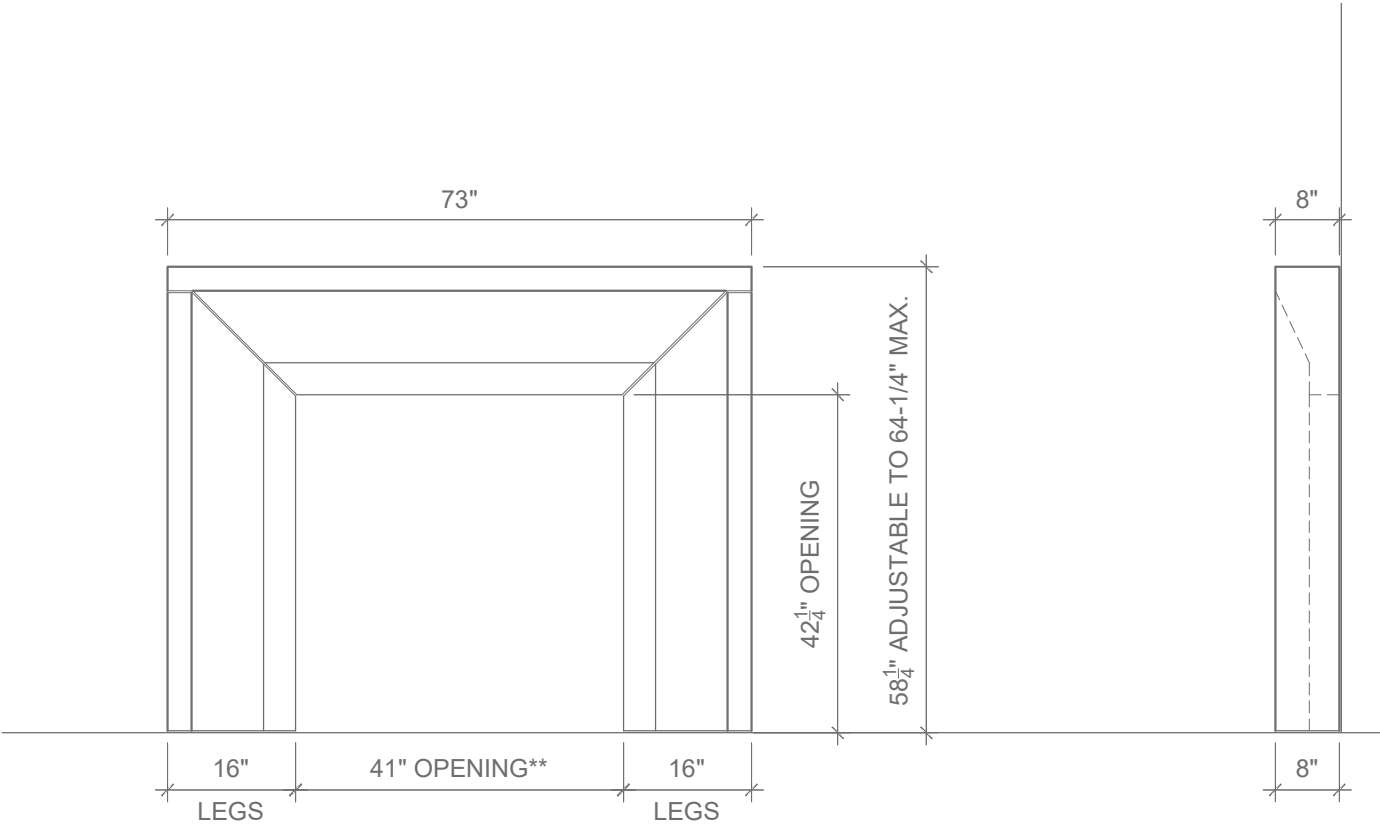

1 FRONT
SCALE: 1/2"=1'-0"

2 SIDE
SCALE: 1/2"=1'-0"

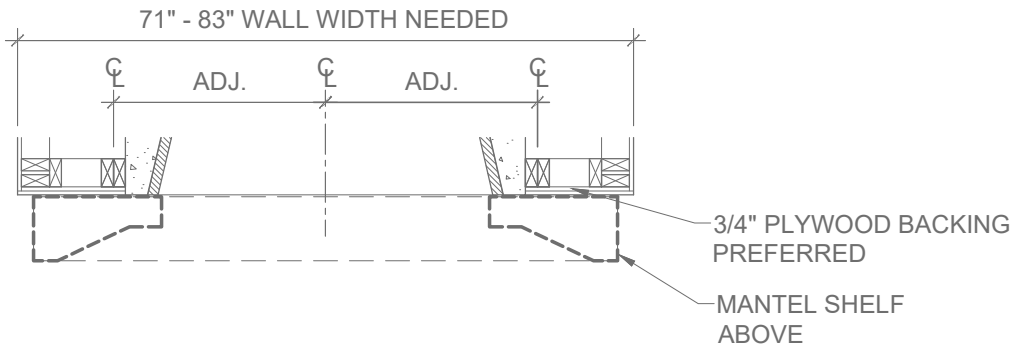

3 FRAMING PLAN
SCALE: 1/2"=1'-0"

*ALL JOINTS ARE AT 1/4" UNLESS NOTED OTHERWISE

HEARTH OPTIONS

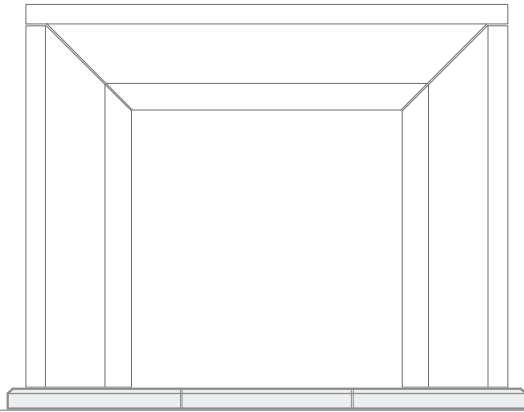

CHAMFERED EDGE
SQUARE HEARTH

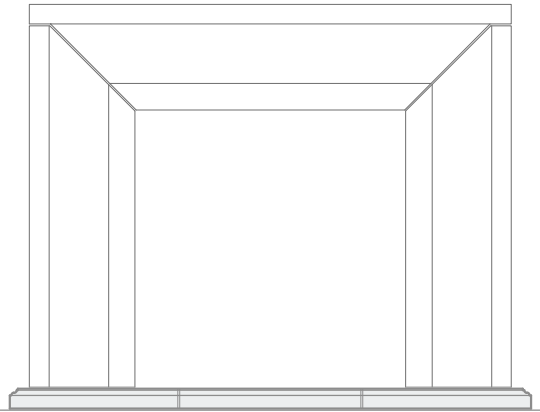

OGEE EDGE
SQUARE HEARTH

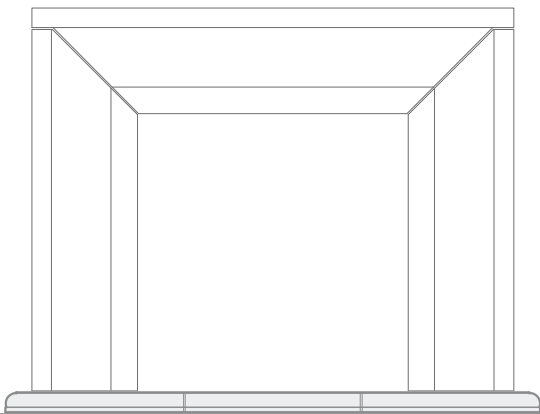

RADIUS EDGE
EYEBROW HEARTH*



*SIZES LIMITED FOR EYEBROW HEARTH

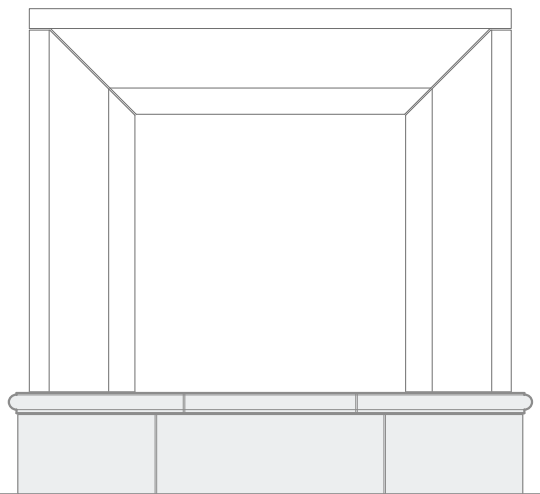

BULLNOSE EDGE, SQUARE
HEARTH WITH RAISED PANELS



VISIT OPTIONS PAGE FOR MORE INFORMATION

FILLER PANEL OPTIONS

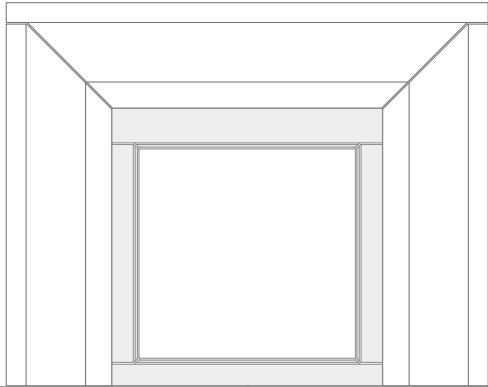

OGEE EDGE, STRAIGHT
FILLER PANEL

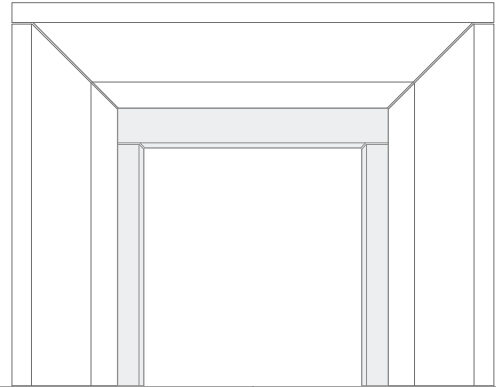

CHAMFER EDGE, STRAIGHT
FILLER PANEL *

*SHOWN WITHOUT BOTTOM PANEL

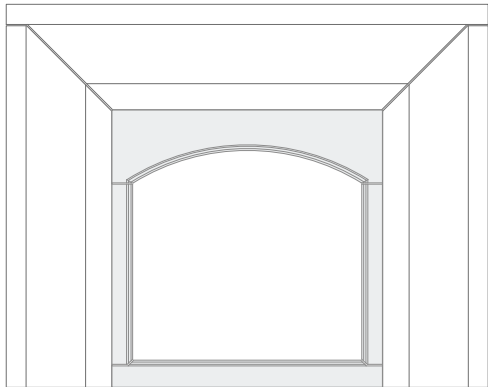

OGEE EDGE, EYEBROW
FILLER PANEL **

**SIZES LIMITED FOR EYEBROW FILLER PANELS

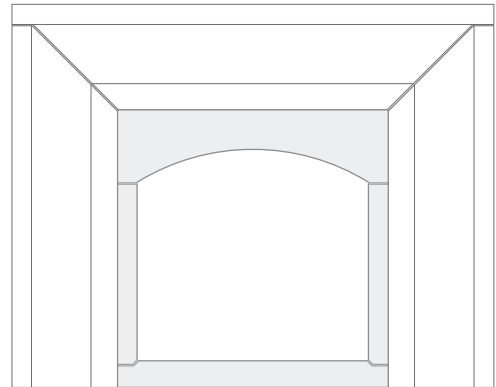

SQUARE EDGE, EYEBROW
FILLER PANEL **

VISIT OPTIONS PAGE FOR MORE INFORMATION